

Levigatrice combinata nastro / disco - Ponceuse a bande/disco
Kombinierte band - und scheibenschleifmaschine



Art.
537B

Cod. / Kode
8286231

Pag.
1/2

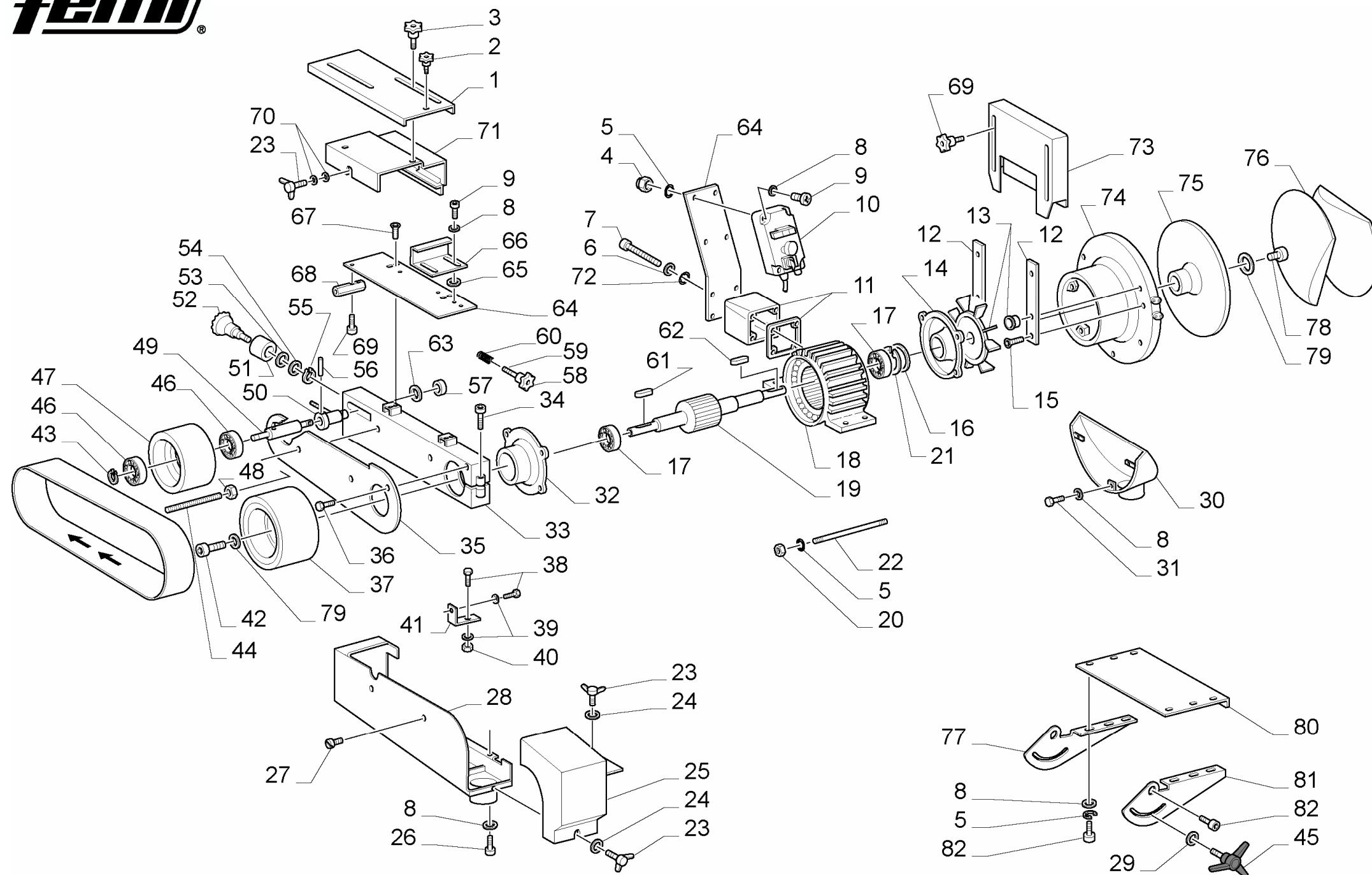

POS.	COD./KOD.	NOTE/MERKE/NOTES/NOTA/NOTAS
1	5.18.17.13	
2	0.14.00.63	
3	0.14.00.64	
4	0.10.21.06	
5	0.12.02.06	
6	0.12.01.05	
7	0.31.05.60	
8	0.12.01.08	
9	0.32.08.20	
10	7.80.02.38	
11	0.04.25.49	
12	5.13.08.09	
13	0.11.20.11	
14	5.04.27.59	
15	0.38.08.15	
16	0.15.50.09	
17	0.52.62.05	
18	7.80.10.72	
19	7.01.36.15	
20	0.10.07.06	
21	0.15.51.07	
22	5.17.30.28	
23	0.10.70.05	
24	0.12.08.06	
25	5.18.22.76	
26	0.32.06.10	
27	0.32.05.10	
28	5.18.17.10	
29	0.12.08.06	
30	5.18.22.75	
31	0.31.06.12	
32	5.04.27.58	
33	5.13.78.96	
34	0.32.10.45	
35	5.18.17.11	
36	0.31.10.16	
37	5.21.40.11	
38	0.31.08.16	
39	0.12.01.08	
40	0.10.01.08	
41	5.13.04.04	
42	0.32.10.20	
43	0.15.11.17	
44	5.12.20.14	
45	5.14.00.10	
46	0.52.62.03	
47	5.21.42.14	
48	0.10.01.10	
49	5.00.20.50	
50	5.13.06.99	
51	5.06.10.32	
52	5.14.00.24	
53	0.12.11.17	
54	5.18.17.18	
55	0.15.11.15	
56	0.15.06.11	
57	0.10.61.35	
58	0.14.00.40	
59	0.41.08.60	
60	5.08.01.11	